

ATE New Parts ATE Neuteile

4/2023



Brakethrough Technology

Höchste Qualität für optimale Leistung.



SUPER DOT 5.1

Der Premium-Allrounder ATE SUPER DOT 5.1 mit bester Funktionalität bei heißen wie kalten Einsatzbedingungen: 5 °C höherer Nass-Siedepunkt und höheres Wechselintervall als ATE SL.6 bei gleich guter Viskosität, ideal für Fahrzeuge mit modernen Fahrerassistenzsystemen wie ESP®, ABS und ASR.

Große Auswahl für alle Einsatzgebiete

- | ATE SL als bewährter DOT 4-Typ, ATE TYP 200 für Rennsportbegeisterte und ATE DOT 3 G für Oldtimer und Fahrzeuge, wo die Verwendung einer DOT 3-Flüssigkeit vom Fahrzeughersteller vorgeschrieben ist
- | ATE SL.6 ist optimal für ESP®, ABS und ASR: dünnflüssig auch bei niedrigen Temperaturen, schnelle Reaktionszeit
- | Siedepunkte und Viskosität übertreffen gesetzliche und technische Anforderungen
- | Schutz vor Korrosion durch hochwertige Additive

Die Eigenschaften von ATE Bremsflüssigkeiten

	Siedepunkt	Nass-Siedepunkt	Viskosität bei -40 °C	Wechselintervall
ATE SUPER DOT 5.1	min. 265 °C	min. 180 °C	max. 750 mm ² /s	bis 3 Jahre
ATE TYP 200 DOT 4 Racing-Qualität	min. 280 °C	min. 198 °C	max. 1.400 mm ² /s	bis 3 Jahre
ATE SL.6 DOT 4 Ideal für ESP®, ABS, ASR	min. 265 °C	min. 175 °C	max. 700 mm ² /s	bis 2 Jahre
ATE SL DOT 4	min. 260 °C	min. 165 °C	max. 1.400 mm ² /s	bis 1 Jahr
ATE DOT 3 G	min. 245 °C	min. 150 °C	max. 1.500 mm ² /s	bis 1 Jahr

Zur Erhaltung der Funktionssicherheit der Bremsanlage muss Bremsflüssigkeit entsprechend der vom Fahrzeughersteller vorgegebenen Qualität und in den angegebenen Wechselintervallen ausgetauscht werden.



Servicegeräte

Natürlich bieten wir auch Geräte für Tests, Entlüftung und Entsorgung von Bremsflüssigkeiten an. Sie arbeiten exakt und zuverlässig, sind leicht zu bedienen und technologisch auf dem neuesten Stand.



In unserem Expert Talk stellen wir Ihnen die verschiedenen Bremsflüssigkeiten vor:



Erfahren Sie mehr über ATE Bremsflüssigkeiten auf www.ate.de/bremsfluessigkeit sowie über unsere Servicegeräte auf www.ate-info.de

Typ	ATE Sachnummer	EAN-Nr. 4006633	Gebinde	Paletteneinheit	
SUPER DOT 5.1	SAE-Spezifikation, J1704-FMVSS 116/DOT 5.1 ISO-Klasse 5.1 – niedrigviskos	706602 03.9901-6602.2	45757 6	1 l	600 Kannen ²
		706603 03.9901-6603.2	45759 0	5 l	400 Kannen ³
		706611 03.9901-6611.2	45761 3	20 l	36 Kannen
		706620 03-9901-6620-2	48735 1	30 l	22 Kannen
		706614 03-9901-6614-2	48734 4	50 l	12 Kannen
TYP 200	SAE-Spezifikation, J1704-FMVSS 116/DOT 4	706202 03.9901-6202.2	10825 6	1 l	600 Kannen ²
		706203 03.9901-6203.2	12166 8	5 l	400 Kannen ³
		706220 03.9901-6220.2	12780 6	30 l	22 Kannen
SL 6	SAE-Spezifikation, J1704-FMVSS 116/DOT 4 ISO-Klasse 6 – niedrigviskos	706402 03.9901-6402.2	20746 1	1 l	600 Kannen ²
		706403 03.9901-6403.2	20748 5	5 l	400 Kannen ³
		706411 03.9901-6411.2	20750 8	20 l	36 Kannen
		706420 03.9901-6420.2	23120 6	30 l	22 Kannen
		706414 03.9901-6414.2	23005 6	50 l	12 Kannen
		706405 03.9901-6405.2	23121 3	200 l	1 Stück
SL	SAE-Spezifikation, J1704-FMVSS 116/DOT 4	705801 03.9901-5801.2	49001 6	1/2 l	1.200 Kannen ¹
		705802 03.9901-5802.2	49002 3	1 l	600 Kannen ²
		705803 03.9901-5803.2	49003 0	5 l	400 Kannen ³
		705811 03.9901-5811.2	29907 7	20 l	12 Kannen
		705820 03.9901-5820.2	10824 9	30 l	22 Kannen
		705814 03.9901-5814.2	10366 4	50 l	12 Kannen
		705805 03.9901-5805.2	49005 4	200 l	1 Stück
G	SAE-Spezifikation, J1703-FMVSS 116/DOT 3	700301 03-9901-0301-2	10188 2	1/2 l	1.200 Kannen ¹
		705302 03.9901-5302.2	10199 8	1 l	600 Kannen ²
		705303 03.9901-5303.2	10201 8	5 l	400 Kannen ³

Abweichende Artikelnummern für Lieferländer außerhalb Deutschlands möglich.

Paletteneinheit:

¹20 Kannen je Karton.

²10 Kannen je Karton.

³4 Kannen je Karton.

Top quality for optimum performance.



SUPER DOT 5.1

ATE SUPER DOT 5.1 with optimum performance in both hot and cold conditions: 5 °C higher wet boiling point than ATE SL.6, same excellent viscosity, longer change interval, ideal for vehicles with advanced driver assistance systems like ESP®, ABS and ASR.

Wide selection for all applications

- | ATE SL as a proven DOT 4 grade, ATE TYP 200 for racing enthusiasts and ATE DOT 3 G for classic cars and vehicles for which the manufacturer specifies a DOT 3 brake fluid
- | ATE SL.6 is optimal for ESP®, ABS and ASR: low viscosity even at low temperatures, with a fast reaction time
- | Boiling points and viscosities are better than in statutory and technical regulations
- | Protection from corrosion by high-grade additives

Properties of ATE brake fluids

	Boiling point	Wet boiling point	Viscosity at -40 °C	Change interval
ATE SUPER DOT 5.1	min. 265 °C/509 °F	min. 180 °C/356 °F	max. 750 mm ² /s	up to 3 years
ATE TYP 200 DOT 4 Racing quality	min. 280 °C/536 °F	min. 198 °C/388 °F	max. 1,400 mm ² /s	up to 3 years
ATE SL.6 DOT 4 Ideal for ESP®, ABS, ASR	min. 265 °C/509 °F	min. 175 °C/347 °F	max. 700 mm ² /s	up to 2 years
ATE SL DOT 4	min. 260 °C/500 °F	min. 165 °C/329 °F	max. 1,400 mm ² /s	up to 1 year
ATE DOT 3 G	min. 245 °C/473 °F	min. 150 °C/302 °F	max. 1,500 mm ² /s	up to 1 year

To maintain the operational reliability and safety of the brake system, you must change the brake fluid in accordance with the vehicle manufacturer's recommendations on quality and at the specified change intervals.



Service units

Of course we also offer devices for testing, bleeding and disposing of brake fluids. The devices work accurately and reliably, are easy to use and their technology is state of the art.



In our Expert Talk we introduce you to the different brake fluids:



To learn more about ATE brake fluids go to www.ate-brakes.com/brakefluid. Information on our service units is available at www.ate-info.de/en

Type	ATE item code	Language variations	Container	Pallet unit
DOT 5.1 SUPER low viscosity	706602 03.9901-6602.2	DE, EN, ES, PT, CN, FR, IT, AR, SE, NL, JP, TH, GR	1 l	600 cans ²
	706612 03.9901-6612.2	PL, RU, CZ, SK, SLO, HU, BG, KA, HR, SR, RO	1 l	600 cans ²
	706603 03.9901-6603.2	DE, EN, ES, PT, CN, FR, IT, AR, SE, NL, JP, TH, GR, PL, RU, CZ, SK, SLO, HU, BG, KA, HR, SR, RO	5 l	400 cans ³
	706611 03.9901-6611.2		20 l	36 cans
	706620 03.9901-6620-2		30 l	22 cans
	706614 03.9901-6614-2		50 l	12 cans
200 TYP	706202 03.9901-6202.2	DE, EN, ES, PT, CN, FR, IT, AR, SE, NL, JP, TH, GR	1 l	600 cans ²
	706212 03.9901-6212.2	PL, RU, CZ, SK, SLO, HU, BG, KA, HR, SR, RO	1 l	600 cans ²
	706203 03.9901-6203.2	DE, EN, PL, ES, CN, FR, IT, RO, AR, SE, RU, HR, SR, CZ, SK, SLO, GR, HU, JP, TH, BG, NL, PT, KA, DK, FI, SQ, TR, LV, NO, LT, MS, HY	5 l	400 cans ³
	706220 03.9901-6220.2	DE, EN, PL, ES, CN, FR, IT, RO, AR, SE, RU, HR, SR, CZ, SK, SLO, GR, HU, JP, TH, BG, NL, PT, KA, DK, FI, SQ, TR	30 l	22 cans
SL6	706402 03.9901-6402.2	DE, EN, ES, PT, CN, FR, IT, AR, SE, NL, JP, TH, GR	1 l	600 cans ²
	706432 03.9901-6432.2	PL, RU, CZ, SK, SLO, HU, BG, KA, HR, SR, RO	1 l	600 cans ²
	706403 03.9901-6403.2	DE, EN, PL, ES, CN, FR, IT, RO, AR, SE, RU, HR, SR, CZ, SK, SLO, GR, HU, JP, TH, BG, NL, PT, KA, DK, FI, SQ, TR, LV, NO, LT, MS, HY	5 l	400 cans ³
	706411 03.9901-6411.2	DE, EN, PL, ES, CN, FR, IT, RO, AR, SE, RU, HR, SR, CZ, SK, SLO, GR, HU, JP, TH, BG, NL, PT, KA, DK, FI, SQ, TR, LV	20 l	36 cans
	706420 03.9901-6420.2	DE, EN, PL, ES, CN, FR, IT, RO, AR, SE, RU, HR, SR, CZ, SK, SLO, GR, HU, JP, TH, BG, NL, PT, KA, DK, FI, SQ, TR	30 l	22 cans
	706414 03.9901-6414.2		50 l	12 cans
706405 03.9901-6405.2		200 l	1 item	
SL	705801 03.9901-5801.2	DE, EN, ES, AR, TH, CN	1/2 l	1,200 cans ¹
	705831 03.9901-5831.2	PL, RO, RU, HR, SLO, KA	1/2 l	1,200 cans ¹
	705802 03.9901-5802.2	DE, EN, ES, PT, CN, FR, IT, AR, SE, NL, JP, TH, GR	1 l	600 cans ²
	705832 03.9901-5832.2	PL, RU, CZ, SK, SLO, HU, BG, KA, HR, SR, RO	1 l	600 cans ²
	705803 03.9901-5803.2	DE, EN, PL, ES, CN, FR, IT, RO, AR, SE, RU, HR, SR, CZ, SK, SLO, GR, HU, JP, TH, BG, NL, PT, KA, DK, FI, SQ, TR, LV, NO, LT, MS, HY	5 l	400 cans ³
	705811 03.9901-5811.2	DE, EN, PL, ES, CN, FR, IT, RO, AR, SE, RU, HR, SR, CZ, SK, SLO, GR, HU, JP, TH, BG, NL, PT, KA, DK, FI, SQ, TR, LV	20 l	12 cans
	705820 03.9901-5820.2	DE, EN, PL, ES, CN, FR, IT, RO, AR, SE, RU, HR, SR, CZ, SK, SLO, GR, HU, JP, TH, BG, NL, PT, KA, DK, FI, SQ, TR	30 l	22 cans
	705814 03.9901-5814.2		50 l	12 cans
705805 03.9901-5805.2		200 l	1 item	
G	700301 03.9901-0301-2	—	1/2 l	1,200 cans ¹
	705302 03.9901-5302.2	—	1 l	600 cans ²
	705303 03.9901-5303.2	—	5 l	400 cans ³
B	700301 03.9901-0301.2	—	1/2 l	1,200 cans ²
	700302 03.9901-0302.2	—	1 l	600 cans ²

Item codes may be different for countries of delivery other than Germany.

Pallet unit: ¹ 20 cans per box. ² 10 cans per box. ³ 4 cans per box.



EN Table of contents

Index of vehicles
Product details
Applications of vehicles
Technical translations

DE Inhaltsverzeichnis

8	Herstellerverzeichnis
10	Produktdetails
17	Fahrzeugverwendungen
29	Technische Übersetzungen

ES Índice

8	Índice de vehículos	8
10	Descripción del producto	10
17	Aplicaciones	17
29	Traducciones técnicas	29

FR Table des matières

Liste des véhicules
Présentation du produit
Applications
Traductions techniques

IT Sommario

8	Indice autovetture	8
10	Panoramica prodotti	10
17	Applicazioni autoveicoli	17
29	Traduzioni tecniche	29



- EN** Index of vehicles
- DE** Herstellerverzeichnis
- ES** Índice de vehículos
- FR** Liste des véhicules
- IT** Indice autovetture

04/2023



**ABARTH 18**

500 / 595 / 695 18
 500C / 595C / 695C 18

AUDI 18

A1 (8X1, 8XK) 18
 A1 Allstreet (GBH) 18
 A1 City Carver (GBH) 18
 A1 Sportback (8XA, 8XF) 18
 A1 Sportback (GBA) 18

CHRYSLER 18

YPSILON 18

CITROËN 18

BERLINGO (ER_, EC_) 18
 BERLINGO Box Body/MPV (K9) 19
 C4 III (BA_, BB_, BC_) 19

DS 19

DS 3 CROSSBACK (UR_, UC_, UJ_) 19

FIAT 19

500 (312_) 19
 500 C (312_) 19
 PANDA (312_, 319_) 19
 PANDA VAN (312_, 519_) 20

HYUNDAI 20

COUPE I (RD) 20
 ELANTRA III (XD) 20
 ELANTRA III Saloon (XD) 20
 ELANTRA LAVITA (FC) 20
 i30 (PDE, PD, PDEN) 20
 i30 FASTBACK (PDE, PDEN) 20

LANCIA 20

YPSILON (312_) 20

LAND ROVER 20

DEFENDER Station Wagon (L663) 21
 DEFENDER Van (L663) 21
 DISCOVERY V (L462) 21
 DISCOVERY V VAN (L462) 21
 RANGE ROVER IV (L405) 21
 RANGE ROVER SPORT II (L494) 21

LEXUS 22

UX (_AA1_, _AH1_, _MA1_) 22

MERCEDES-BENZ 22

A-CLASS (W177) 22
 A-CLASS Saloon (V177) 22
 B-CLASS Sports Tourer (W247) 22
 CLA (C118) 22
 CLA Shooting Brake (X118) 22
 GLA (H247) 22
 GLB (X247) 22
 X-CLASS (470) 23
 X-CLASS Platform/Chassis (470) 23

NISSAN 23

NAVARA Pickup (D23, D23T) 23

OPEL 23

ADAM (M13) 23

**OPEL 23**

COMBO Box Body/MPV (K9) 23
 COMBO E Tour / Life (K9) 23
 CORSA F (P2JO) 23
 CORSA F Hatchback Van 23
 MOKKA 23

PEUGEOT 23

2008 II (UD_, US_, UY_, UK_) 24
 208 II (UB_, UP_, UW_, UJ_) 24
 PARTNER Box Body/MPV (K9) 24
 RIFTER 24

SEAT 24

ARONA (KJ7, KJP) 24
 IBIZA IV (6J5, 6P1) 24
 IBIZA IV SC (6J1, 6P5) 24
 IBIZA IV ST (6J8, 6P8) 25
 IBIZA V (KJ1, KJG) 25
 TOLEDO IV (KG3) 25

SKODA 25

FABIA III (NJ3) 25
 FABIA III Estate (NJ5) 25
 FABIA IV (PJ3) 25
 KAMIQ (NW4) 25
 RAPID (NH3, NK3, NK6) 26
 RAPID Spaceback (NH1) 26
 SCALA (NW1) 26

SUBARU 26

FORESTER (SK_) 26
 IMPREZA Hatchback (GT_) 26
 XV (GT) 26

TOYOTA 26

CAMRY (_V7_, _VA7_, _VH7_) 26
 COROLLA Cross (ZVG1_, ZSG1_, MXGH1_, MXGA1_) 27
 PROACE CITY Box Body/MPV 27
 PROACE CITY VERSO MPV 27
 RAV 4 V (_A5_, _H5_) 27
 RAV 4 V VAN (_A5_, _H5_) 27
 YARIS (_P13_) 27
 YARIS Hatchback Van (_P13_) 27

VAUXHALL 27

ADAM (M13) 27
 COMBO Mk IV (E) Box Body/MPV (K9) 28
 COMBO Mk IV (E) Life (K9) 28
 CORSA Mk V (F) 28
 MOKKA 28

VW 28

POLO VI (AW1, BZ1, AE1) 28



- EN** Product details
- DE** Produktdetails
- ES** Descripción del producto
- FR** Présentation du produit
- IT** Panoramica prodotti

04/2023



13.0460-2635.2

602635



Brake Pad Set, disc brake

Thickness [mm] 17.3
 Width [mm] 92
 Height [mm] 47
 TRW
 + Zub
 with brake caliper screws

CITROËN, OPEL, PEUGEOT, TOYOTA, VAUXHALL

13.0460-2644.2

602644



92,1 x 39,0 x 17,7

26198 17,7

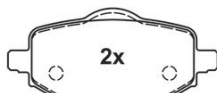

92,1 x 43,0 x 17,7

26199 17,7

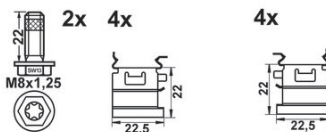

Brake Pad Set, disc brake

Height 2 [mm]: 43
 Thickness [mm] 17.7
 Width [mm] 92.1
 TRW
 - WE / - WK
 + Zub
 Height 1 [mm]: 39
 with brake caliper screws

CITROËN, DS, OPEL, PEUGEOT, VAUXHALL

13.0460-3888.2

603888



22861 18,7

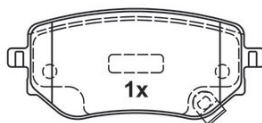

22862 18,7

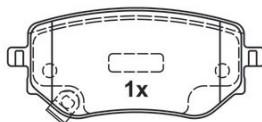

22863 18,7

112,8 x 48,1 x 18,7

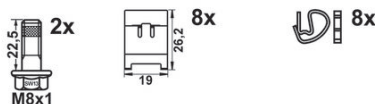

Brake Pad Set, disc brake

Thickness [mm] 18.7
 Width [mm] 112.8
 Height [mm] 48.1
 + WK
 + Zub
 with brake caliper screws

MERCEDES-BENZ, NISSAN

13.0460-3891.2

603891

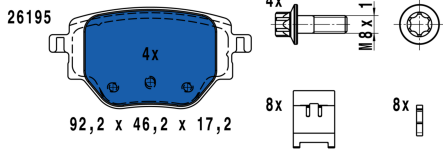

Brake Pad Set, disc brake

Thickness [mm] 17.2

Width [mm] 92.2

Height [mm] 46.2

- WE / - WK

+ Zub

with brake caliper screws

OPEL, PEUGEOT, VAUXHALL

13.0460-4899.2

604899

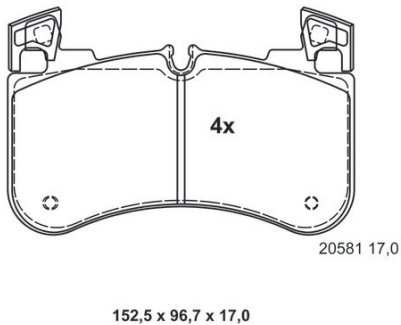

Brake Pad Set, disc brake

+ WE / - WK

Thickness [mm] 18.7

Width [mm] 152.5

Height [mm] 96.7

BRE

LAND ROVER

13.0460-5533.2

605533



Brake Pad Set, disc brake

- WE / - WK

Thickness [mm] 16.5

Width [mm] 142.5

Height [mm] 55.9

AKE

LEXUS, TOYOTA

13.0460-5534.2

605534



Brake Pad Set, disc brake

- WE / - WK

Thickness [mm] 15

Width [mm] 103.5

Height [mm] 47.5

TOYOTA



13.0460-5536.2

605536



Brake Pad Set, disc brake

Thickness 2 [mm] 20.9

Thickness 1 [mm] 20.1

Width [mm] 140.5

Height [mm] 61.3

+ WK

+ Zub

HYUNDAI

13.0460-5545.2

605545

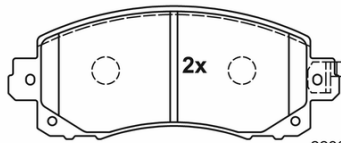

22800 16,9

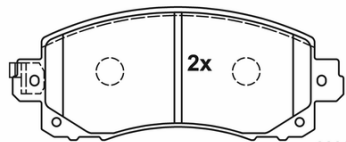

22801 16,9

145,3 x 58,4 x 16,9

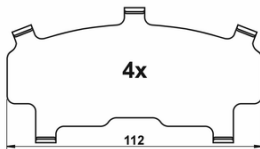

4x

112



Brake Pad Set, disc brake

Thickness [mm] 16.9

Width [mm] 145.3

Height [mm] 58.4

TOK

+ WK

with anti-squeak plate

SUBARU

13.0470-3881.2

LD3881



Brake Pad Set, disc brake

Height 2 [mm]: 68.9

Thickness [mm] 19.7

Width [mm] 135.3

+ WE / - WK

+ Zub

Height 1 [mm]: 74.4

with brake caliper screws

MERCEDES-BENZ

13.0470-3888.2

LD3888

ATE Ceramic



22861 18,7

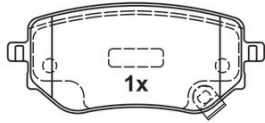

22862 18,7

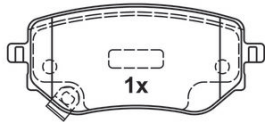

22863 18,7

112,8 x 48,1 x 18,7



2x



8x



8x



Brake Pad Set, disc brake

Thickness [mm] 18.7

Width [mm] 112.8

Height [mm] 48.1

+ WK

+ Zub

with brake caliper screws

MERCEDES-BENZ, NISSAN

13.0470-4899.2

LD4899

ATE Ceramic

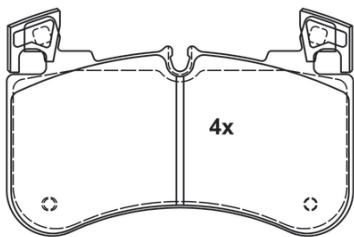

20581 17,0

152,5 x 96,7 x 17,0



Brake Pad Set, disc brake

Thickness [mm] 18.7

Width [mm] 152.5

Height [mm] 96.7

BRE

+ WE / - WK

LAND ROVER

13.0470-5533.2

LD5533



Brake Pad Set, disc brake

Thickness [mm] 16.5

Width [mm] 142.5

Height [mm] 55.9

AKE

- WE / - WK

LEXUS, TOYOTA

13.0470-5534.2

LD5534



Brake Pad Set, disc brake

Thickness [mm] 15

Width [mm] 103.5

Height [mm] 47.5

- WE / - WK

TOYOTA

13.0470-5536.2

LD5536



Brake Pad Set, disc brake

Thickness 2 [mm] 20.9

Thickness 1 [mm] 20.1

Width [mm] 140.5

Height [mm] 61.3

+ WK

+ Zub

HYUNDAI

24.2122-1785.3

011114



Brake Master Cylinder

Ø 22.2

2x M12x1

2x

without brake fluid reservoir

L1= 27.9

L2= 96

TOYOTA

24.3541-1885.5

241519



Brake Caliper

Service exchange part

without holder

MAN

Piston Diameter [mm]: 54

HYUNDAI

24.3541-1887.5

241511



Brake Caliper

Service exchange part

without holder

MAN

Piston Diameter [mm]: 54

AUDI, SEAT, SKODA, VW

24.3541-1888.5

241512



Brake Caliper

Service exchange part

without holder

MAN

Piston Diameter [mm]: 54

AUDI, SEAT, SKODA, VW

24.5104-0378.3

331681



Brake Hose

L= 400

Spanner size 1 [mm]: 14

Spanner size 2 [mm]: 17

ABARTH, CHRYSLER, FIAT, LANCIA

24.5204-0351.3

331661

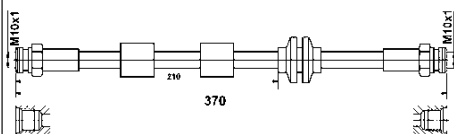

Brake Hose

Spanner Size: 17,0

L= 370

Internal Thread 1 [mm]: M10x1

OPEL, VAUXHALL





EN Applications of vehicles

DE Fahrzeugverwendungen

















ES Aplicaciones















FR Applications















IT Applicazioni autoveicoli













04/2023



































	kw			 	! #		
ABARTH - 500 / 595 / 695 01/08→							
 Brake Hose							
1.4	99 - 121	08/08→	←		2	24.5104-0378.3 331681	L= 400
ABARTH - 500C / 595C / 695C 05/08→							
 Brake Hose							
1.4	99 - 132	05/08→	←		2	24.5104-0378.3 331681	L= 400
AUDI - A1 (8X1, 8XK) 05/10→10/18							
 Brake Caliper							
1.0 TFSI	60 - 70	03/15→10/18	←	+PR 1ZG; ☐		24.3541-1887.5 241511	MAN without holder
1.2 TFSI	63	05/10→04/15	←	+PR 1ZG; ☐		24.3541-1888.5 241512	MAN without holder
1.4 TDI	66	11/14→10/18					
1.4 TFSI	90 - 136	05/10→10/18					
1.4 TSI	110	11/14→10/18					
1.6 TDI	66 - 85	05/10→10/18					
1.8 TFSI	141	02/15→10/18					
2.0 TDI	100 - 105	09/11→04/15					
2.0 TFSI quattro	188	03/12→11/12	←	10/12→; +PR 1ZG; ☐		24.3541-1887.5 241511	MAN without holder
			←	10/12→; +PR 1ZG; ☐		24.3541-1888.5 241512	MAN without holder
AUDI - A1 Allstreet (GBH) 07/19→							
 Brake Caliper							
25 TFSI	70	07/22→	←	+PR 1ZG; ☐		24.3541-1887.5 241511	MAN without holder
30 TFSI	81	07/22→	←	+PR 1ZG; ☐		24.3541-1888.5 241512	MAN without holder
35 TFSI	110	07/22→	←	+PR 1ZG; ☐			
AUDI - A1 City Carver (GBH) 07/19→							
 Brake Caliper							
25 TFSI	70	07/19→	←	+PR 1ZG; ☐		24.3541-1887.5 241511	MAN without holder
30 TFSI	81 - 85	07/19→	←	+PR 1ZG; ☐		24.3541-1888.5 241512	MAN without holder
35 TFSI	110	07/19→					
AUDI - A1 Sportback (8XA, 8XF) 09/11→10/18							
 Brake Caliper							
1.0 TFSI	60 - 70	03/15→10/18	←	+PR 1ZG; ☐		24.3541-1887.5 241511	MAN without holder
1.2 TFSI	63	01/12→04/15	←	+PR 1ZG; ☐		24.3541-1888.5 241512	MAN without holder
1.4 TDI	66	11/14→10/18					
1.4 TFSI	90 - 136	11/11→10/18					
1.4 TSI	110	11/14→10/18					
1.6 TDI	66 - 85	11/11→10/18					
1.8 TFSI	141	02/15→10/18					
2.0 TDI	100 - 105	09/11→04/15					
AUDI - A1 Sportback (GBA) 07/18→							
 Brake Caliper							
25 TFSI	70	11/18→	←	+PR 1ZG; ☐		24.3541-1887.5 241511	MAN without holder
30 TFSI	81 - 85	07/18→	←	+PR 1ZG; ☐		24.3541-1888.5 241512	MAN without holder
35 TFSI	110	09/18→					
40 TFSI	147 - 152	09/18→					
CHRYSLER - YPSILON 05/11→							
 Brake Hose							
0.9 Twinair	63	05/11→	←		2	24.5104-0378.3 331681	L= 400
1.2	51	05/11→					
1.3 Multijet	70	05/11→					
CITROËN - BERLINGO (ER_, EC_) 06/18→							
 Brake Pad Set, disc brake							
1.2 PureTech 110	81	06/18→	→	- eFSB		13.0460-2635.2 602635	TRW + Zub
1.2 PureTech 130	96	07/19→					
1.5 BlueHDi 100	75	06/18→					





















	kW					! #		
CITROËN - BERLINGO (ER_, EC_) 06/18→								
 Brake Pad Set, disc brake								
1.5 BlueHDi 130 1.5 BlueHDi 75 e-Berlingo	96 56 100	06/18→ 06/18→ 07/21→	→	- eFSB			13.0460-2635.2 602635	TRW + Zub
CITROËN - BERLINGO Box Body/MPV (K9) 06/18→								
 Brake Pad Set, disc brake								
1.5 BlueHDi 100 1.5 BlueHDi 130 1.5 BlueHDi 130 4x4 1.5 BlueHDi 75 1.6 BlueHDi 100 1.6 BlueHDi 75 e-Berlingo PureTech 110 PureTech 130	75 96 96 55 73 55 100 81 96	06/18→ 06/18→ 06/18→ 10/19→ 06/18→ 06/18→ 07/21→ 06/18→ 10/19→	→	- eFSB			13.0460-2635.2 602635	TRW + Zub
CITROËN - C4 III (BA_, BB_, BC_) 10/20→								
 Brake Pad Set, disc brake								
1.2 PureTech 100 1.2 PureTech 130 1.2 PureTech 155 1.5 BlueHDi 130 BLUEHDI 110	74 96 114 96 81	04/21→ 10/20→ 01/21→ 10/20→ 12/20→	→				13.0460-2644.2 602644	TRW - WE / - WK + Zub
DS - DS 3 CROSSBACK (UR_, UC_, UJ_) 10/18→								
 Brake Pad Set, disc brake								
1.2 PureTech 100 1.2 PureTech 130 1.2 PureTech 155 1.5 BlueHDi 100 1.5 BlueHDi 110 1.5 BlueHDi 130	74 96 115 75 81 96	10/18→ 10/18→ 10/18→ 10/18→ 01/21→ 10/18→	→				13.0460-2644.2 602644	TRW - WE / - WK + Zub
FIAT - 500 (312_) 07/07→								
 Brake Hose								
0.9 1.0 Mild Hybrid 1.2 1.2 LPG 1.3 D Multijet 1.4 1.4 Turbo	44 - 63 51 51 51 55 - 70 74 - 75 101	07/10→ 01/20→ 07/07→ 12/10→ 10/07→ 10/07→ 09/13→	←				2 24.5104-0378.3 331681	L= 400
0.9 Electric	77 24 - 83	10/13→ 01/10→	←	12/13→			2 24.5104-0378.3 331681	L= 400
FIAT - 500 C (312_) 09/09→								
 Brake Hose								
0.9 1.0 Mild Hybrid 1.2 1.3 D Multijet 1.4	44 - 77 51 51 55 - 70 74 - 75	09/09→ 01/20→ 09/09→ 09/09→ 09/09→	←				2 24.5104-0378.3 331681	L= 400
FIAT - PANDA (312_, 319_) 02/12→								
 Brake Hose								
0.9 0.9 4x4 0.9 Natural Power 1.0 Mild Hybrid 1.2 1.2 LPG 1.3 D Multijet 1.3 D Multijet 4x4	44 - 63 63 - 66 51 - 63 51 51 51 55 - 70 55 - 70	02/12→ 09/12→ 07/12→ 01/20→ 02/12→ 06/12→ 02/12→ 06/12→	←				2 24.5104-0378.3 331681	L= 400

































	kW					! #		
FIAT - PANDA VAN (312_, 519_) 02/12→								
 Brake Hose								
0.9	48 - 63	02/12→	←			2	24.5104-0378.3 331681	L= 400
0.9 4x4	63	09/12→						
0.9 Natural Power	59 - 63	07/12→						
1.2	51	02/12→						
1.2 LPG	51	06/12→						
1.3 D Multijet	55 - 59	02/12→						
1.3 D Multijet 4x4	55 - 59	06/12→						
HYUNDAI - COUPE I (RD) 05/96→04/02								
 Brake Caliper								
1.6 16V	85	03/98→04/02	←	09/98→; ☐			24.3541-1885.5 241519	MAN without holder
1.6 i 16V	84	12/96→04/02						
2.0 16V	102	08/96→04/02						
1.6 i 16V	79	08/00→01/02	←	☐			24.3541-1885.5 241519	MAN without holder
2.0	101	08/99→01/02						
2.0 16V	99	03/01→04/02						
F2 Evolution	115	01/99→12/01						
HYUNDAI - ELANTRA III (XD) 03/00→08/06								
 Brake Caliper								
1.5 VVTi	77	08/03→05/06	←	☐			24.3541-1885.5 241519	MAN without holder
1.6	66 - 79	06/00→07/06	←	→ 05/06; ☐			24.3541-1885.5 241519	MAN without holder
1.8	97	06/00→07/06						
2.0	102 - 105	06/00→07/06						
2.0 CRDi	83	04/01→07/06						
1.6	77	05/03→07/06	←	08/03→ 05/06; ☐			24.3541-1885.5 241519	MAN without holder
HYUNDAI - ELANTRA III Saloon (XD) 03/00→09/06								
 Brake Caliper								
1.6	66 - 79	06/00→07/06	←	→ 05/06; ☐			24.3541-1885.5 241519	MAN without holder
1.8	97	06/00→07/06						
2.0	102 - 105	06/00→07/06						
2.0 CRDi	83	04/01→07/06						
1.6	77	05/03→05/06	←	08/03→; ☐			24.3541-1885.5 241519	MAN without holder
1.8	79	06/00→07/03	←	☐			24.3541-1885.5 241519	MAN without holder
HYUNDAI - ELANTRA LAVITA (FC) 06/01→08/10								
 Brake Caliper								
1.5 CRDi	60	10/01→08/10	←	→ 02/02; ☐			24.3541-1885.5 241519	MAN without holder
1.6	76	06/01→08/10						
1.8	90	06/01→08/10						
HYUNDAI - i30 (PDE, PD, PDEN) 11/16→								
 Brake Pad Set, disc brake								
2.0 N	184 - 202	07/17→	←	Brake Size: 19"			13.0460-5536.2 605536 13.0470-5536.2 LD5536	+ WK + Zub + WK + Zub Ceramic
HYUNDAI - i30 FASTBACK (PDE, PDEN) 06/17→								
 Brake Pad Set, disc brake								
2.0 N	184 - 202	07/17→	←	Brake Size: 19"			13.0460-5536.2 605536 13.0470-5536.2 LD5536	+ WK + Zub + WK + Zub Ceramic
LANCIA - YPSILON (312_) 05/11→								
 Brake Hose								
0.9 CNG	59 - 63	05/11→	←			2	24.5104-0378.3 331681	L= 400
0.9 TwinAir	59 - 63	05/11→						
1.0 Mild Hybrid	51	03/20→						
1.2	51	05/11→						
1.2 Bi-fuel	49	05/11→						
1.3 D Multijet	70	05/11→08/18						
1.2 Bi-fuel	51	05/11→	←	04/15→		2	24.5104-0378.3 331681	L= 400























	kw					! #		
LAND ROVER - DEFENDER Station Wagon (L663) 09/19→								
 Brake Pad Set, disc brake								
D200 MHEV 4x4 D200 SD4 4x4 D240 SD4 4x4 D250 MHEV 4x4 P300 Si4 4x4	147 147 177 183 221	09/19→ 09/19→ 09/19→ 09/20→ 09/19→	←	→ L2999999; for brake disc diameter [mm]: 363; Brake Size: 19"		13.0460-4899.2 13.0470-4899.2	604899 LD4899	BRE + WE / - WK BRE + WE / - WK Ceramic
D300 MHEV 4x4 P400e Hybrid 4x4 P400 I6 MHEV 4x4	221 297 294	09/20→ 09/20→ 09/19→	←	→ L2999999; for brake disc diameter [mm]: 363; Brake Size: 19"		13.0460-4899.2	604899	BRE + WE / - WK
LAND ROVER - DEFENDER Van (L663) 02/20→								
 Brake Pad Set, disc brake								
2.0 D200 SD4 4x4 2.0 D240 SD4 4x4 2.0 P300 Si4 4x4 3.0 D200 MHEV 4x4 3.0 D250 MHEV 4x4	147 177 221 147 183	02/20→ 02/20→ 02/20→ 09/20→ 09/20→	←	→ L2999999; for brake disc diameter [mm]: 363; Brake Size: 19"		13.0460-4899.2 13.0470-4899.2	604899 LD4899	BRE + WE / - WK BRE + WE / - WK Ceramic
2.0 P400e Hybrid 4x4 3.0 D300 MHEV 4x4 3.0 P400 I6 MHEV 4x4	297 221 294	09/20→ 09/20→ 02/20→	←	→ L2999999; for brake disc diameter [mm]: 363; Brake Size: 19"		13.0460-4899.2	604899	BRE + WE / - WK
LAND ROVER - DISCOVERY V (L462) 09/16→								
 Brake Pad Set, disc brake								
2.0 Sd4 4x4 2.0 Si4 4x4 2.0 Td4 4x4 3.0 D 4x4 3.0 Td6 4x4	177 221 132 155 - 183 190	09/16→ 09/17→ 09/16→ 09/16→ 09/16→	←	JA000001→; Brake Size: 19"		13.0460-4899.2 13.0470-4899.2	604899 LD4899	BRE + WE / - WK BRE + WE / - WK Ceramic
3.0 D250 MHEV 4x4 3.0 D300 MHEV 4x4	183 221	12/20→ 12/20→	←	Brake Size: 19"; Vehicle Production Country Great Britain		13.0460-4899.2 13.0470-4899.2	604899 LD4899	BRE + WE / - WK BRE + WE / - WK Ceramic
			←	Brake Size: 19"; Vehicle Production Country Slovakia; → L2999999		13.0460-4899.2 13.0470-4899.2	604899 LD4899	BRE + WE / - WK BRE + WE / - WK Ceramic
3.0 P360 MHEV 4x4	265	12/20→	←	Brake Size: 19"; Vehicle Production Country Great Britain		13.0460-4899.2	604899	BRE + WE / - WK
			←	Brake Size: 19"; Vehicle Production Country Slovakia; → L2999999		13.0460-4899.2	604899	BRE + WE / - WK
3.0 SCV6 4x4 3.0 SDV6 4x4	250 225	09/16→ 09/18→	←	JA000001→; Brake Size: 19"		13.0460-4899.2 13.0460-4899.2	604899 604899	BRE + WE / - WK BRE + WE / - WK
			←	Brake Size: 19"		13.0470-4899.2	LD4899	BRE + WE / - WK Ceramic
LAND ROVER - DISCOVERY V VAN (L462) 09/16→								
 Brake Pad Set, disc brake								
2.0 Sd4 4x4 2.0 Si4 4x4 2.0 Td4 4x4 3.0 Td6 4x4	177 221 132 190	09/16→ 09/17→ 09/16→12/18 09/16→	←	JA000001→; Brake Size: 19"		13.0460-4899.2 13.0470-4899.2	604899 LD4899	BRE + WE / - WK BRE + WE / - WK Ceramic
3.0 D300 MHEV 4x4	221	12/20→	←	Brake Size: 19"; Vehicle Production Country Great Britain		13.0460-4899.2 13.0470-4899.2	604899 LD4899	BRE + WE / - WK BRE + WE / - WK Ceramic
			←	Brake Size: 19"; Vehicle Production Country Slovakia; → L2999999		13.0460-4899.2 13.0470-4899.2	604899 LD4899	BRE + WE / - WK BRE + WE / - WK Ceramic
3.0 Scv6 4x4 3.0 Sdv6 4x4	250 225	09/16→ 09/18→	←	JA000001→; Brake Size: 19"		13.0460-4899.2 13.0460-4899.2	604899 604899	BRE + WE / - WK BRE + WE / - WK
			←	Brake Size: 19"		13.0470-4899.2	LD4899	BRE + WE / - WK Ceramic
LAND ROVER - RANGE ROVER IV (L405) 08/12→								
 Brake Pad Set, disc brake								
2.0 P400e Hybrid 4x4 3.0 P400 4x4 D350 MHEV 4x4	297 294 258	10/17→ 07/20→ 07/20→	←	JA000001→ LA999999; Rim Size [in]: 19		13.0460-4899.2 13.0460-4899.2	604899 604899	BRE + WE / - WK BRE + WE / - WK
3.0 SDV6 4x4 3.0 TDV6 4x4	182 - 215 155 - 190	08/12→ 08/12→	←	JA000001→ LA999999; Rim Size [in]: 19		13.0460-4899.2 13.0470-4899.2	604899 LD4899	BRE + WE / - WK BRE + WE / - WK Ceramic
3.0 SDV6 4x4 D250 MHEV 4x4 D300 MHEV 4x4	202 183 221	10/18→ 07/20→ 07/20→	←	Rim Size [in]: 19; → LA999999		13.0460-4899.2 13.0470-4899.2	604899 LD4899	BRE + WE / - WK BRE + WE / - WK Ceramic
LAND ROVER - RANGE ROVER SPORT II (L494) 04/13→								
 Brake Pad Set, disc brake								
3.0 D250 4x4 →	183	07/20→	←	Rim Size [in]: 19; → LA999999		13.0460-4899.2	604899	BRE + WE / - WK















	kw					! #		
LAND ROVER - RANGE ROVER SPORT II (L494) 04/13→								
 Brake Pad Set, disc brake								
3.0 D250 MHEV 4x4	183	07/20→	←	Rim Size [in]: 19; → LA999999		13.0470-4899.2	LD4899	BRE + WE / - WK Ceramic
3.0 D300 4x4	221	07/20→						
3.0 D300 MHEV 4x4	221	07/20→						
3.0 D350 4x4	258	07/20→	←	Rim Size [in]: 19; → LA999999		13.0460-4899.2	604899	BRE + WE / - WK
3.0 D350 MHEV 4x4	258	07/20→						
LEXUS - UX (_AA1_, _AH1_, _MA1_) 10/18→								
 Brake Pad Set, disc brake								
200	110 - 127	10/18→	←			13.0460-5533.2	605533	AKE - WE / - WK
250h	131 - 135	10/18→				13.0470-5533.2	LD5533	AKE - WE / - WK Ceramic
250h E-Four	131 - 135	10/18→						
300e	150	04/20→						
MERCEDES-BENZ - A-CLASS (W177) 03/18→								
 Brake Pad Set, disc brake								
A 220	140	07/18→	←	for vehicles without AMG sports package; for vehicles without sports brake system		13.0470-3881.2	LD3881	+ WE / - WK + Zub Ceramic
A 220 4-matic	140	07/18→10/19						
A 220 d	140	11/18→						
A 220 d 4-matic	140	10/19→						
MERCEDES-BENZ - A-CLASS Saloon (V177) 09/18→								
 Brake Pad Set, disc brake								
A 220	140	01/19→	←	for vehicles without AMG sports package; for vehicles without sports brake system		13.0470-3881.2	LD3881	+ WE / - WK + Zub Ceramic
A 220 4-matic	140	09/18→						
A 220 d	140	08/19→						
A 220 d 4-matic	140	10/19→						
MERCEDES-BENZ - B-CLASS Sports Tourer (W247) 12/18→								
 Brake Pad Set, disc brake								
B 220	140	04/19→	←	for vehicles without AMG sports package; for vehicles without sports brake system		13.0470-3881.2	LD3881	+ WE / - WK + Zub Ceramic
B 220 4-matic	140	01/19→						
B 220 d	140	12/18→						
B 220 d 4-matic	140	10/19→						
MERCEDES-BENZ - CLA (C118) 03/19→								
 Brake Pad Set, disc brake								
CLA 220	140	03/19→	←	for vehicles without AMG sports package; for vehicles without sports brake system		13.0470-3881.2	LD3881	+ WE / - WK + Zub Ceramic
CLA 220 4-matic	140	03/19→						
CLA 220 d	140	04/19→						
CLA 220 d 4-matic	140	07/20→						
MERCEDES-BENZ - CLA Shooting Brake (X118) 06/19→								
 Brake Pad Set, disc brake								
CLA 220	140	06/19→	←	for vehicles without AMG sports package; for vehicles without sports brake system		13.0470-3881.2	LD3881	+ WE / - WK + Zub Ceramic
CLA 220 d	140	06/19→						
CLA 220 d 4-matic	140	10/19→						
MERCEDES-BENZ - GLA (H247) 02/20→								
 Brake Pad Set, disc brake								
GLA 180	100	07/20→	←	for vehicles without AMG sports package; for vehicles without sports brake system; Vehicle Main Current: for vehicles with 48V main current		13.0470-3881.2	LD3881	+ WE / - WK + Zub Ceramic
GLA 180 d	85	03/20→	←	for vehicles without AMG sports package; for vehicles without sports brake system		13.0470-3881.2	LD3881	+ WE / - WK + Zub Ceramic
GLA 200	120	02/20→						
GLA 200 4-matic	120	10/20→						
GLA 200 d	110	02/20→						
GLA 200 d 4-matic	110	02/20→						
MERCEDES-BENZ - GLB (X247) 07/19→								
 Brake Pad Set, disc brake								
GLB 180	100	04/20→	←	for vehicles without AMG sports package; for vehicles without sports brake system		13.0470-3881.2	LD3881	+ WE / - WK + Zub Ceramic
GLB 200	120	08/19→						
GLB 200 4-matic	120	10/20→						
GLB 180 d	85	08/19→	←	for vehicles without sports brake system; for vehicles without 3rd seating row		13.0470-3881.2	LD3881	+ WE / - WK + Zub Ceramic













	kW					! #		
MERCEDES-BENZ - X-CLASS (470) 09/17→05/20								
 Brake Pad Set, disc brake								
X 220 d	120	09/17→05/20	➔				13.0460-3888.2 603888	+ WK + Zub
X 220 d 4-matic	120	09/17→05/20					13.0470-3888.2 LD3888	+ WK + Zub Ceramic
X 250 d	140	09/17→05/20						
X 250 d 4-matic	140	09/17→05/20						
X 350 d 4-matic	190	07/18→05/20						
MERCEDES-BENZ - X-CLASS Platform/Chassis (470) 09/17→								
 Brake Pad Set, disc brake								
X 220 d	120	09/17→	➔				13.0460-3888.2 603888	+ WK + Zub
X 250 d 4-matic	140	09/17→					13.0470-3888.2 LD3888	+ WK + Zub Ceramic
NISSAN - NAVARA Pickup (D23, D23T) 07/14→								
 Brake Pad Set, disc brake								
2.3 dCi	120 - 140	01/15→	➔	05/19→			13.0460-3888.2 603888	+ WK + Zub
2.3 dCi 4x4	116 - 140	01/15→					13.0470-3888.2 LD3888	+ WK + Zub Ceramic
2.5 dCi	120	07/14→						
2.5 dCi 4x4	120 - 140	07/14→						
OPEL - ADAM (M13) 10/12→02/19								
 Brake Hose								
1.0	66 - 85	07/14→11/18	➔	Drum Brake	2	24.5204-0351.3 331661	L= 370	
1.2	51	10/12→02/19	➔	Disc Brake	2	24.5204-0351.3 331661	L= 370	
1.4	64 - 74	10/12→02/19						
1.4 LPG	64	07/13→11/18						
1.4 S	110	11/14→01/19						
OPEL - COMBO Box Body/MPV (K9) 06/18→								
 Brake Pad Set, disc brake								
1.2	81 - 96	02/19→	➔	- eFSB		13.0460-2635.2 602635	TRW + Zub	
1.5 D	56 - 96	08/18→						
1.5 D 4x4	96	08/18→						
1.6 D	55 - 73	06/18→						
Combo-e	100	07/21→						
OPEL - COMBO E Tour / Life (K9) 06/18→								
 Brake Pad Set, disc brake								
1.2	81 - 96	06/18→	➔	- eFSB		13.0460-2635.2 602635	TRW + Zub	
1.5	56 - 96	06/18→						
Combo-e	100	06/21→						
OPEL - CORSA F (P2JO) 07/19→								
 Brake Pad Set, disc brake								
1.2	55 - 96	07/19→	➔	+ eFSB		13.0460-2644.2 602644	TRW - WE / - WK + Zub	
1.5	75	07/19→	➔	- eFSB		13.0460-3891.2 603891	- WE / - WK + Zub	
CORSA-e	100	07/19→						
OPEL - CORSA F Hatchback Van 07/19→								
 Brake Pad Set, disc brake								
1.2	55	07/19→	➔	+ eFSB		13.0460-2644.2 602644	TRW - WE / - WK + Zub	
1.5	75	07/19→	➔	- eFSB		13.0460-3891.2 603891	- WE / - WK + Zub	
OPEL - MOKKA 06/20→								
 Brake Pad Set, disc brake								
1.2	74 - 96	10/20→	➔	+ eFSB		13.0460-2644.2 602644	TRW - WE / - WK + Zub	
1.5	81	10/20→						

	kW					! #		
PEUGEOT - 208 II (UB_, UP_, UW_, UJ_) 06/19→								
 Brake Pad Set, disc brake								
1.2 PureTech 100	74	06/19→	➔	+ eFSB		13.0460-2644.2	602644	TRW - WE / - WK + Zub
1.2 PureTech 130	96	06/19→						
1.2 PureTech 75	55	06/19→	➔	- eFSB		13.0460-3891.2	603891	- WE / - WK + Zub
1.2 VTi 82	60	06/19→						
1.5 BlueHDI 100	75	06/19→						
1.5 BlueHDI 130	96	09/19→						
1.6 HDI 90	68	10/19→						
1.6 VTi 115	85	11/19→						
PEUGEOT - 2008 II (UD_, US_, UY_, UK_) 08/19→								
 Brake Pad Set, disc brake								
1.2 PureTech 100	74	11/19→	➔	+ eFSB		13.0460-2644.2	602644	TRW - WE / - WK + Zub
1.2 PureTech 130	96	08/19→						
1.2 THP / PureTech 155	114	11/19→	➔	- eFSB		13.0460-3891.2	603891	- WE / - WK + Zub
1.5 BlueHDI 100	75	08/19→						
1.5 BlueHDI 110	81	01/21→						
1.5 BlueHDI 130	96	08/19→						
PEUGEOT - PARTNER Box Body/MPV (K9) 09/18→								
 Brake Pad Set, disc brake								
1.2 PureTech 110	81	07/19→	➔	- eFSB		13.0460-2635.2	602635	TRW + Zub
1.2 PureTech 130	96	07/19→						
1.5 BlueHDI 100	75	07/19→						
1.5 BlueHDI 130	96	09/18→						
1.5 BlueHDI 130 4x4	96	09/18→						
1.5 BlueHDI 75	55	07/19→						
1.6 BlueHDI 100	73	09/18→						
1.6 BlueHDI 75	55	09/18→						
e-Partner	100	07/21→						
PEUGEOT - RIFTER 09/18→								
 Brake Pad Set, disc brake								
1.2 PureTech 110	81	09/18→	➔	- eFSB		13.0460-2635.2	602635	TRW + Zub
1.2 PureTech 130	96	07/19→						
1.5 BlueHDI 100	75	09/18→						
1.5 BlueHDI 130	96	09/18→						
1.5 BlueHDI 75	55	09/18→						
1.6 BlueHDI 100	73	09/18→						
1.6 HDi 75 / BlueHDI 75	55	09/18→						
1.6 HDi 92	68	09/18→						
e-Rifter	100	07/21→						
SEAT - ARONA (KJ7, KJP) 07/17→								
 Brake Caliper								
1.0 TGi	66	11/18→	←	+PR 1ZG; 		24.3541-1887.5	241511	MAN without holder
1.0 TSI	70 - 85	07/17→						
1.5 TSI	110	07/17→	←	+PR 1ZG; 		24.3541-1888.5	241512	MAN without holder
1.6 SRE	81	07/17→						
1.6 TDI	70 - 85	07/17→						
SEAT - IBIZA IV (6J5, 6P1) 03/08→12/17								
 Brake Caliper								
1.0	55	05/15→06/17	←	+PR 1ZG; 		24.3541-1887.5	241511	MAN without holder
1.0 TSI	70 - 81	05/15→06/17						
1.2 TSI	66 - 81	05/15→06/17	←	+PR 1ZG; 		24.3541-1888.5	241512	MAN without holder
1.4 TDI	55 - 77	05/15→06/17						
1.6	81	07/15→06/17						
SEAT - IBIZA IV SC (6J1, 6P5) 06/08→12/18								
 Brake Caliper								
1.0	55	05/15→12/16	←	+PR 1ZG; 		24.3541-1887.5	241511	MAN without holder
1.0 TSI	70 - 81	05/15→12/16						
1.2 TSI	66 - 81	05/15→12/16	←	+PR 1ZG; 		24.3541-1888.5	241512	MAN without holder
1.4 TDI	55 - 77	05/15→12/16						
1.6	81	07/15→12/16						
1.8 TSI Cupra	141	11/15→12/16						

	kW			 	! #			
SEAT - IBIZA IV ST (6J8, 6P8) 03/10→07/16								
 Brake Caliper								
1.0	55	05/15→07/16	←	+PR 1ZG; 		24.3541-1887.5	241511	MAN without holder
1.0 TSI	70 - 81	05/15→07/16	←	+PR 1ZG; 		24.3541-1888.5	241512	MAN without holder
1.2 TSI	66 - 81	05/15→07/16						
1.4 TDI	55 - 77	05/15→07/16						
SEAT - IBIZA V (KJ1, KJG) 01/17→								
 Brake Caliper								
1.0	48 - 55	01/17→	←	+PR 1ZG; 		24.3541-1887.5	241511	MAN without holder
1.0 MPi	59	07/18→	←	+PR 1ZG; 		24.3541-1888.5	241512	MAN without holder
1.0 TGI	66	11/17→						
1.0 TSI	70 - 85	01/17→						
1.5 TSI	110	07/17→						
1.6	81	05/17→						
1.6 TDI	59 - 85	09/17→						
SEAT - TOLEDO IV (KG3) 07/12→04/19								
 Brake Caliper								
1.0 TSI	70 - 81	05/17→04/19	←	+PR 1ZG; 		24.3541-1887.5	241511	MAN without holder
1.2 TSI	66 - 81	05/15→05/17	←	+PR 1ZG; 		24.3541-1888.5	241512	MAN without holder
1.4 TDI	66	05/15→04/19						
1.4 TSI	92	05/15→04/19						
1.6 TDI	85	05/15→04/19						
SKODA - FABIA III (NJ3) 08/14→06/21								
 Brake Caliper								
1.0	44 - 55	08/14→06/21	←	05/15→; +PR 1ZG; 		24.3541-1887.5	241511	MAN without holder
1.0 TSI	70 - 81	08/14→06/21	←	05/15→; +PR 1ZG; 		24.3541-1888.5	241512	MAN without holder
1.2 TSI	66 - 81	08/14→06/21						
1.4 TDI	66 - 77	08/14→06/21						
1.6	81	01/15→06/21						
1.4 TDI	55	05/15→06/21	←	+PR 1ZG; 		24.3541-1887.5	241511	MAN without holder
1.4 TSI R5	92	02/18→06/21	←	+PR 1ZG; 		24.3541-1888.5	241512	MAN without holder
SKODA - FABIA III Estate (NJ5) 08/14→								
 Brake Caliper								
1.0	44 - 55	10/14→	←	05/15→; +PR 1ZG; 		24.3541-1887.5	241511	MAN without holder
1.0 TSI	70 - 81	08/14→	←	05/15→; +PR 1ZG; 		24.3541-1888.5	241512	MAN without holder
1.2 TSI	66 - 81	10/14→						
1.4 TDI	66 - 77	10/14→						
1.6	81	01/15→						
1.4 TDI	55	05/15→	←	+PR 1ZG; 		24.3541-1887.5	241511	MAN without holder
			←	+PR 1ZG; 		24.3541-1888.5	241512	MAN without holder
SKODA - FABIA IV (PJ3) 06/21→								
 Brake Caliper								
1.0 MPi	48 - 59	06/21→	←	+PR 1ZG; 		24.3541-1887.5	241511	MAN without holder
1.0 TSI	70 - 81	06/21→	←	+PR 1ZG; 		24.3541-1888.5	241512	MAN without holder
1.5 TSI	110	11/21→						
1.6	81	06/21→						
SKODA - KAMIQ (NW4) 07/19→								
 Brake Caliper								
1.0 TGI CNG	66	11/19→	←	+PR 1ZG; 		24.3541-1887.5	241511	MAN without holder
1.0 TSI	70 - 85	07/19→	←	+PR 1ZG; 		24.3541-1888.5	241512	MAN without holder
1.5 TSI	110	07/19→						

	kw			 	! #			
SKODA - KAMIQ (NW4) 07/19→								
 Brake Caliper								
1.6 SRE	81	07/19→	←	+PR 1ZG; 		24.3541-1887.5	241511	MAN without holder
1.6 TDI	70 - 85	07/19→	←	+PR 1ZG; 		24.3541-1888.5	241512	MAN without holder
SKODA - RAPID (NH3, NK3, NK6) 07/12→								
 Brake Caliper								
1.0 TSI	70 - 81	06/17→12/19	←	+PR 1ZG; 		24.3541-1887.5	241511	MAN without holder
1.2 TSI	66 - 81	05/15→12/19	←	+PR 1ZG; 		24.3541-1888.5	241512	MAN without holder
1.4 TDI	66	05/15→12/19						
1.4 TSI	92	05/15→12/19						
1.6 TDI	85	05/15→12/19						
SKODA - RAPID Spaceback (NH1) 07/12→12/19								
 Brake Caliper								
1.0 TSI	70 - 81	06/17→12/19	←	+PR 1ZG; 		24.3541-1887.5	241511	MAN without holder
1.2 TSI	66 - 81	05/15→12/19	←	+PR 1ZG; 		24.3541-1888.5	241512	MAN without holder
1.4 TDI	66	05/15→12/19						
1.4 TSI	92	05/15→12/19						
1.6 TDI	85	05/15→12/19						
SKODA - SCALA (NW1) 02/19→								
 Brake Caliper								
1.0 TGI CNG	66	11/19→	←	+PR 1ZG; 		24.3541-1887.5	241511	MAN without holder
1.0 TSI	70 - 85	02/19→	←	+PR 1ZG; 		24.3541-1888.5	241512	MAN without holder
1.5 TSI	110	02/19→						
1.6 SRE	81	02/19→						
1.6 TDI	70 - 85	02/19→						
SUBARU - FORESTER (SK_) 04/18→								
 Brake Pad Set, disc brake								
2.0 AWD	115	04/18→	←			13.0460-5545.2	605545	TOK + WK
2.0 e-Boxer Hybrid AWD	107 - 110	04/18→						
i AWD	113	06/20→						
2.5 AWD	136	04/18→	←	Engine Code: FB25C		13.0460-5545.2	605545	TOK + WK
SUBARU - IMPREZA Hatchback (GT_) 10/16→								
 Brake Pad Set, disc brake								
1.6 i	84 - 85	10/16→	←			13.0460-5545.2	605545	TOK + WK
1.6 i AWD	85	10/16→						
2.0 i AWD	115	10/16→						
SUBARU - XV (GT) 04/17→								
 Brake Pad Set, disc brake								
1.6 i AWD	84	08/17→	←			13.0460-5545.2	605545	TOK + WK
2.0 AWD	113	04/17→						
2.0 i AWD	110 - 115	04/17→						
2.0 i e-BOXER AWD	107 - 110	10/19→						
TOYOTA - CAMRY (_V7_, _VA7_, _VH7_) 06/17→								
 Brake Pad Set, disc brake								
2.0	110	10/17→	←			13.0460-5533.2	605533	AKE - WE / - WK
2.5	133 - 154	08/17→				13.0470-5533.2	LD5533	AKE - WE / - WK Ceramic
3.5	183 - 224	08/17→						
2.0	123	10/18→	←	G / N		13.0460-5533.2	605533	AKE - WE / - WK
2.5	131 - 152	08/17→				13.0470-5533.2	LD5533	AKE - WE / - WK Ceramic
2.5 Hybrid	153 - 160	08/17→						

	kW			 	! #		
TOYOTA - COROLLA Cross (ZVG1_, ZSG1_, MXGH1_, MXGA1_) 07/20→							
 Brake Pad Set, disc brake							
2.0 VVTi Hybrid	144	08/22→	←			13.0460-5533.2 605533	AKE - WE / - WK
2.0 VVTi Hybrid AWD	144	08/22→				13.0470-5533.2 LD5533	AKE - WE / - WK Ceramic
TOYOTA - PROACE CITY Box Body/MPV 10/19→							
 Brake Pad Set, disc brake							
1.2 VVT-i 110	81	10/19→	→	- eFSB		13.0460-2635.2 602635	TRW + Zub
1.2 VVT-i 130	96	10/19→					
1.5 D-4D 100	75	10/19→					
1.5 D-4D 130	96	10/19→					
1.5 D-4D 75	55	10/19→					
Electric	100	07/21→					
TOYOTA - PROACE CITY VERSO MPV 10/19→							
 Brake Pad Set, disc brake							
1.2 VVT-i 110	81	10/19→	→	- eFSB		13.0460-2635.2 602635	TRW + Zub
1.2 VVT-i 130	96	10/19→					
1.5 D-4D 100	75	10/19→					
1.5 D-4D 130	96	10/19→					
Electric	100	07/21→					
TOYOTA - RAV 4 V (_A5_, _H5_) 12/18→							
 Brake Pad Set, disc brake							
2.0	129	12/18→	←	Manufacturer Restriction NBK		13.0460-5533.2 605533	AKE - WE / - WK
2.0 AWD	129	12/18→				13.0470-5533.2 LD5533	AKE - WE / - WK Ceramic
2.0 VVTi	110 -	12/18→					
	127		→			13.0460-5534.2 605534	- WE / - WK
2.0 VVTi AWD	110 -	12/18→				13.0470-5534.2 LD5534	- WE / - WK Ceramic
	127						
2.5 Hybrid	160	12/18→					
2.5 Hybrid AWD	163	12/18→					
2.5 VVTi AWD	152	12/18→					
2.5 VVTi	149	12/18→	←			13.0460-5533.2 605533	AKE - WE / - WK
2.5 VVTi AWD	149	12/18→				13.0470-5533.2 LD5533	AKE - WE / - WK Ceramic
			→			13.0460-5534.2 605534	- WE / - WK
						13.0470-5534.2 LD5534	- WE / - WK Ceramic
TOYOTA - RAV 4 V VAN (_A5_, _H5_) 12/18→							
 Brake Pad Set, disc brake							
2.0 VVTi	129	12/18→	←	Manufacturer Restriction NBK		13.0460-5533.2 605533	AKE - WE / - WK
2.0 VVTi AWD	129	12/18→				13.0470-5533.2 LD5533	AKE - WE / - WK Ceramic
2.5 Hybrid	160	12/18→					
2.5 Hybrid AWD	163	12/18→	→			13.0460-5534.2 605534	- WE / - WK
						13.0470-5534.2 LD5534	- WE / - WK Ceramic
TOYOTA - YARIS (_P13_) 12/10→							
 Brake Master Cylinder							
1.0	51	12/10→		for left-hand drive vehicles; Vehicle Production Country France; + ESP		24.2122-1785.3 011114	Ø 22.2 without brake fluid reservoir
1.3	63 -	12/10→					
	73						
1.3 4WD	70	12/10→					
1.5	80	12/10→					
1.0	53	06/18→		for left-hand drive vehicles; + ESP		24.2122-1785.3 011114	Ø 22.2 without brake fluid reservoir
1.4 D	66	09/11→					
1.5	82	03/17→					
1.8 GRMN	156	09/17→		for left-hand drive vehicles		24.2122-1785.3 011114	Ø 22.2 without brake fluid reservoir
TOYOTA - YARIS Hatchback Van (_P13_) 10/12→							
 Brake Master Cylinder							
1.0 VVTi	51	07/14→		for left-hand drive vehicles; Vehicle Production Country France; + ESP		24.2122-1785.3 011114	Ø 22.2 without brake fluid reservoir
1.3 VVTi	73	10/12→					
1.0 VVTi	53	06/18→		+ ESP; for left-hand drive vehicles		24.2122-1785.3 011114	Ø 22.2 without brake fluid reservoir
1.4 D4d	66	07/14→					
1.5 VVTi	82	03/17→		+ ESP		24.2122-1785.3 011114	Ø 22.2 without brake fluid reservoir
Vauxhall - ADAM (M13) 10/12→04/19							
 Brake Hose							
1.0	85	07/14→11/18	→	Disc Brake	2	24.5204-0351.3 331661	L= 370
1.2	51	10/12→04/19	→	Drum Brake	2	24.5204-0351.3 331661	L= 370
→							

	kW			 	! #		
VAUXHALL - ADAM (M13) 10/12→04/19							
 Brake Hose							
1.4	64 - 74	10/12→02/19	➡	Disc Brake	2	24.5204-0351.3 331661	L= 370
1.4 S	110	11/14→01/19	➡	Drum Brake	2	24.5204-0351.3 331661	L= 370
VAUXHALL - COMBO Mk IV (E) Box Body/MPV (K9) 06/18→							
 Brake Pad Set, disc brake							
1.2	81	02/19→	➡	- eFSB		13.0460-2635.2 602635	TRW + Zub
1.5 D	56 - 96	08/18→					
1.5 D 4x4	96	08/18→					
1.6 D	55 - 73	06/18→					
Combo-e	100	07/21→					
VAUXHALL - COMBO Mk IV (E) Life (K9) 06/18→							
 Brake Pad Set, disc brake							
1.2	81 - 96	06/18→	➡	- eFSB		13.0460-2635.2 602635	TRW + Zub
1.5	75 - 96	06/18→					
Combo-e	100	06/21→					
VAUXHALL - CORSA Mk V (F) 07/19→							
 Brake Pad Set, disc brake							
1.2	55 - 96	07/19→	➡	+ eFSB		13.0460-2644.2 602644	TRW - WE / - WK + Zub
1.5	75	07/19→	➡	- eFSB		13.0460-3891.2 603891	- WE / - WK + Zub
CORSA-e	100	07/19→					
VAUXHALL - MOKKA 06/20→							
 Brake Pad Set, disc brake							
1.2	74 - 96	10/20→	➡	+ eFSB		13.0460-2644.2 602644	TRW - WE / - WK + Zub
1.5	81	10/20→					
VW - POLO VI (AW1, BZ1, AE1) 06/17→							
 Brake Caliper							
1.0	48 - 55	06/17→08/21	←	09/17→; +PR 1ZG / 1ZJ; ☐		24.3541-1887.5 241511	MAN without holder
1.0 TSI	70	06/17→	←	09/17→; +PR 1ZG / 1ZJ; ☐		24.3541-1888.5 241512	MAN without holder
1.0 MPI	59	09/18→	←	+PR 1ZG / 1ZJ; ☐		24.3541-1887.5 241511	MAN without holder
1.0 TGI	66	09/17→					
1.0 TSI	81 - 85	09/17→	←	+PR 1ZG / 1ZJ; ☐		24.3541-1888.5 241512	MAN without holder
1.5 TSI	110	10/18→08/21					
1.6 MSi	81	09/17→					
1.6 TDI	59 - 70	11/17→02/21					
2.0 GTI	147	11/17→					
GTI	152	04/21→					









- EN** Technical translations
- DE** Technische Übersetzungen
- ES** Traducciones técnicas
- FR** Traductions techniques
- IT** Traduzioni tecniche

04/2023



Technical translations







Technische Übersetzungen - Traducciones tecnicas - Traductions techniques - Traduzioni tecniche

EN		EN	
	Brake Master Cylinder	for vehicles with 48V main current	for vehicles with 48V main current
	Brake Hose	for vehicles without 3rd seating row	for vehicles without 3rd seating row
	Brake Caliper	for vehicles without AMG sports package	for vehicles without AMG sports package
	Brake Pad Set, disc brake	for vehicles without sports brake system	for vehicles without sports brake system
	Front Axle Left	France	France
	Front Axle Right	Great Britain	Great Britain
+ eFSB	for vehicles with electric parking brake	Height [mm]	Height [mm]
+ ESP	for vehicles with ESP	Height 1 [mm]	Height 1 [mm]
+PR	for PR number	Height 2 [mm]	Height 2 [mm]
+ WE	prepared for wear indicator	Internal Thread 1 [mm]	Internal Thread 1 [mm]
+ WK	with acoustic wear warning	L=	Length [mm]
+ Zub	with accessories	L1=	Length 1 [mm]
19"	19"	L2=	Length 2 [mm]
Abfrage Produktbild vorhanden	Abfrage Produktbild vorhanden	MAN	Brake System, Mando
AKE	Brake System, Akebono	Manufacturer Restriction	Manufacturer Restriction
ATE Ceramic	additional article information, ATE Ceramic	Piston Diameter [mm]	Piston Diameter [mm]
Brake Size	Brake Size	Produkttyp vorhanden	Produkttyp vorhanden
BRE	Brake System, Brembo	Reached Quality Gates	Reached Quality Gates
Country specific package and status data	Country specific package and status data	replacement part	replacement part
Disc Brake	Disc Brake	Rim Size [in]	Rim Size [in]
Drum Brake	Drum Brake	Service exchange part	Service exchange part
- eFSB	for vehicles without electric parking brake	Slovakia	Slovakia
Engine Code	Engine Code	Spanner Size	Spanner Size
for brake disc diameter [mm]	for brake disc diameter [mm]		
for left-hand drive vehicles	for left-hand drive vehicles		



Technical translations

Technische Übersetzungen - Traducciones tecnicas - Traductions techniques - Traduzioni tecniche

EN		DE	
Spanner size 1 [mm]	Spanner size 1 [mm]		Hauptbremszylinder
Spanner size 2 [mm]	Spanner size 2 [mm]		Bremsschlauch
Thickness [mm]	Thickness [mm]		Bremssattel
Thickness 1 [mm]	Thickness 1 [mm]		Bremsbelagsatz, Scheibenbremse
Thickness 2 [mm]	Thickness 2 [mm]		Vorderachse links
TOK	Brake System, Tokico		Vorderachse rechts
TRW	Brake System, Lucas / TRW		
usage number	usage number	+ eFSB	für Fahrzeuge mit elektrischer Feststellbremse
Vehicle Main Current	Vehicle Main Current	+ ESP	für Fahrzeuge mit ESP
Vehicle Production Country	Vehicle Production Country	+PR	für PR-Nummer
- WE	not prepared for wear indicator	+ WE	für Verschleißwarnanzeiger vorbereitet
Width [mm]	Width [mm]	+ WK	mit akustischer Verschleißwarnung
with anti-squeak plate	with anti-squeak plate	+ Zub	mit Zubehör
with brake caliper screws	with brake caliper screws	19"	19"
without brake fluid reservoir	without brake fluid reservoir	Abfrage Produktbild vorhanden	Abfrage Produktbild vorhanden
- WK	excl. wear warning contact	AKE	Bremssystem, Akebono
x	Number of connectors	ATE Ceramic	Artikelzusatzbezeichnung, ATE Ceramic
Yes	Yes	Brake Size	Bremsengröße
Ø	Diameter [mm]	BRE	Bremssystem, Brembo
→	Construction year from Vehicle Identification Number (VIN) from	Country specific package and status data	Länderspezifische Verpackungs- und Status-Informationen
→	Construction year to Vehicle Identification Number (VIN) to	Disc Brake	Scheibenbremse
		Drum Brake	Trommelbremse
		- eFSB	für Fahrzeuge ohne elektrische Feststellbremse
		Engine Code	Motorcode
		for brake disc diameter [mm]	für Bremsscheibendurchmesser [mm]
		for left-hand drive vehicles	für Linkslenker

Technical translations

Technische Übersetzungen - Traducciones tecnicas - Traductions techniques - Traduzioni tecniche

DE		DE	
for vehicles with 48V main current	für Fahrzeuge mit 48V Bordnetz	Spanner size 1 [mm]	Schlüsselweite 1 [mm]
for vehicles without 3rd seating row	für Fahrzeuge ohne 3. Sitzreihe	Spanner size 2 [mm]	Schlüsselweite 2 [mm]
for vehicles without AMG sports package	für Fahrzeuge ohne AMG-Sportpaket	Thickness [mm]	Dicke/Stärke [mm]
for vehicles without sports brake system	für Fahrzeuge ohne Sportbremsanlage	Thickness 1 [mm]	Dicke/Stärke 1 [mm]
France	Frankreich	Thickness 2 [mm]	Dicke/Stärke 2 [mm]
Great Britain	Groß Britannien	TOK	Bremssystem, Tokico
Height [mm]	Höhe [mm]	TRW	Bremssystem, Lucas / TRW
Height 1 [mm]	Höhe 1 [mm]	usage number	Gebrauchsnummer
Height 2 [mm]	Höhe 2 [mm]	Vehicle Main Current	Bordnetzausführung
Internal Thread 1 [mm]	Innengewinde 1 [mm]	Vehicle Production Country	Fahrzeugproduktionsland
L=	Länge [mm]	- WE	nicht für Verschleißwarnanzeiger vorbereitet
L1=	Länge 1 [mm]	Width [mm]	Breite [mm]
L2=	Länge 2 [mm]	with anti-squeak plate	mit Anti-Quietsch-Blech
MAN	Bremssystem, Mando	with brake caliper screws	mit Bremssattelschrauben
Manufacturer Restriction	Herstellereinschränkung	without brake fluid reservoir	ohne Bremsflüssigkeitsbehälter
Piston Diameter [mm]	Kolbendurchmesser [mm]	- WK	exkl. Verschleißwarnkontakt
Produkttyp vorhanden	Produkttyp vorhanden	x	Anschlussanzahl
Reached Quality Gates	Erfüllte Qualitätsstufen	Yes	Ja
replacement part	Austauschteil	Ø	Durchmesser [mm]
Rim Size [in]	Felgengröße [Zoll]	→	Baujahr ab Fahrgestellnummer (VIN) ab
Service exchange part	Austauschteil	→	Baujahr bis Fahrgestellnummer (VIN) bis
Slovakia	Slowakische Republik		
Spanner Size	Schlüsselweite		





Technical translations

Technische Übersetzungen - Traducciones técnicas - Traductions techniques - Traduzioni tecniche

ES		ES	
	Cilindro principal de freno	for vehicles with 48V main current	para vehículos con red de a bordo 48V
	Tubo flexible de frenos	for vehicles without 3rd seating row	para vehículos sin 3 hileras de asientos
	Pinza de freno	for vehicles without AMG sports package	para vehículos sin paquete deportivo AMG
	Juego de pastillas de freno	for vehicles without sports brake system	para vehículos sin sistema de frenos deportivos
	Eje delantero, izquierda	France	Francia
	Eje delantero, derecha	Great Britain	Gran Bretaña
+ eFSB	para vehículos con freno de estacionamiento electrónico	Height [mm]	Altura [mm]
+ ESP	para vehículos con ESP	Height 1 [mm]	Altura 1 [mm]
+PR	Número de PR	Height 2 [mm]	Altura 2 [mm]
+ WE	preparado para indicador desgaste	Internal Thread 1 [mm]	Rosca interior 1 [mm]
+ WK	con avisador acústico de desgaste	L=	Longitud [mm]
+ Zub	con accesorios	L1=	Longitud 1 [mm]
19"	19"	L2=	Longitud 2 [mm]
Abfrage Produktbild vorhanden	Abfrage Produktbild vorhanden	MAN	Sistema de frenos, Mando
AKE	Sistema de frenos, Akebono	Manufacturer Restriction	Restricción de fabricante
ATE Ceramic	Denominación adicional del artículo, ATE Ceramic	Piston Diameter [mm]	Diámetro del pistón [mm]
Brake Size	Tamaño freno	Produkttyp vorhanden	Produkttyp vorhanden
BRE	Sistema de frenos, Brembo	Reached Quality Gates	Reached Quality Gates
Country specific package and status data	Información específica del país sobre el embalaje y sobre el estado	replacement part	Recambio
Disc Brake	Discos	Rim Size [in]	Tamaño de llanta [in]
Drum Brake	Tambor	Service exchange part	Pieza de intercambio
- eFSB	para vehículos sin freno de estacionamiento electrónico	Slovakia	República eslovaca
Engine Code	Código de motor	Spanner Size	Ancho de llave
for brake disc diameter [mm]	para diámetro disco de freno [mm]		
for left-hand drive vehicles	para vehic. dirección izquierda		

Technical translations

Technische Übersetzungen - Traducciones técnicas - Traductions techniques - Traduzioni tecniche

ES		FR	
Spanner size 1 [mm]	Ancho de llave 1 [mm]		Maître-cylindre de frein
Spanner size 2 [mm]	Ancho de llave 2 [mm]		Flexible de frein
Thickness [mm]	Espesor [mm]		Étrier de frein
Thickness 1 [mm]	Espesor/grosor 1 [mm]		Kit de plaquettes de frein, frein à disque
Thickness 2 [mm]	Espesor/grosor 2 [mm]		Essieu avant gauche
TOK	Sistema de frenos, Tokico		Essieu avant droit
TRW	Sistema de frenos, Lucas / TRW		
usage number	Número de uso	+ eFSB	pour véhicules avec frein d'arrêt électrique
Vehicle Main Current	Modelo red de a bordo	+ ESP	pour véhicules avec ESP
Vehicle Production Country	País producción vehículo	+PR	pour numéro PR
- WE	no preparado para indicador de desgaste	+ WE	préparé pour indicateur d'usure
		+ WK	avec indicateur d'usure
		+ Zub	avec accessoires
Width [mm]	Ancho [mm]	19"	19"
with anti-squeak plate	Chapa antichirridos	Abfrage Produktbild vorhanden	Abfrage Produktbild vorhanden
with brake caliper screws	con tornillos pinza freno	AKE	Système de freinage, Akebono
without brake fluid reservoir	sin depósito líquido frenos	ATE Ceramic	Designation d'article complémentaire, ATE Ceramic
- WK	excl. contacto de avisador de desgaste	Brake Size	Dimension des freins
x	Número de conexiones	BRE	Système de freinage, Brembo
Yes	sí	Country specific package and status data	Informations d'emballage et d'état spécifiques aux pays
Ø	Diámetro [mm]	Disc Brake	Frein à disque
→	año construcción desde N.º de chasis (VIN) desde	Drum Brake	Frein à tambour
→	año construcción hasta N.º de chasis (VIN) hasta	- eFSB	pour véhicules sans frein d'arrêt électrique
		Engine Code	Code moteur
		for brake disc diameter [mm]	pour diamètre du disque de frein [mm]
		for left-hand drive vehicles	pour véhicules avec direction à gauche







Technical translations

Technische Übersetzungen - Traducciones técnicas - Traductions techniques - Traduzioni tecniche

FR		FR	
for vehicles with 48V main current	pour véhicules avec réseau de bord de 48V	Spanner size 1 [mm]	Largeur de clé 1 [mm]
for vehicles without 3rd seating row	pour véhicules sans 3ième rangée de sièges	Spanner size 2 [mm]	Largeur de clé 2 [mm]
for vehicles without AMG sports package	pour véhicules sans pack sport AMG	Thickness [mm]	Épaisseur [mm]
for vehicles without sports brake system	pour véhicules sans système de freinage sport	Thickness 1 [mm]	Épaisseur 1 [mm]
France	France	Thickness 2 [mm]	Épaisseur 2 [mm]
Great Britain	Grande-Bretagne	TOK	Système de freinage, Tokico
Height [mm]	Hauteur [mm]	TRW	Système de freinage, Lucas / TRW
Height 1 [mm]	Hauteur 1 [mm]	usage number	Numéro d'utilisation
Height 2 [mm]	Hauteur 2 [mm]	Vehicle Main Current	Type de réseau de bord
Internal Thread 1 [mm]	Taraudage 1 [mm]	Vehicle Production Country	Pays constructeur du véhicule
L=	Longueur [mm]	- WE	non préparé pour indicateur d'usure
L1=	Longueur 1 [mm]	Width [mm]	Largeur [mm]
L2=	Longueur 2 [mm]	with anti-squeak plate	avec tôle anti-bruit
MAN	Système de freinage, Mando	with brake caliper screws	avec vis d'étrier de frein
Manufacturer Restriction	Montage d'origine	without brake fluid reservoir	sans réservoir du liquide de frein
Piston Diameter [mm]	Diamètre du piston [mm]	- WK	contact de signal d'usure exclu
Produkttyp vorhanden	Produkttyp vorhanden	x	Nombre de connexions
Reached Quality Gates	Reached Quality Gates	Yes	Oui
replacement part	Pièce de rechange	∅	Diamètre [mm]
Rim Size [in]	Dimension de la jante [pouces]	→	Année à partir de Numéro de châssis (VIN) à partir de
Service exchange part	Echange standard	→	Année jusqu'à Numéro de châssis (VIN) à
Slovakia	République slovaque		
Spanner Size	Ouverture de la clé		

Technical translations

Technische Übersetzungen - Traducciones técnicas - Traductions techniques - Traduzioni tecniche

IT		IT	
	Cilindro maestro del freno	for left-hand drive vehicles	per veicolo con guida a Sx
	Flessibile del freno	for vehicles with 48V main current	per veicoli con impianto elettrico di bordo a 48 Volt
	Pinza freno	for vehicles without 3rd seating row	per veicoli senza 3ª fila sedili
	Kit pastiglie freno, Freno a disco	for vehicles without AMG sports package	per veicoli senza pacchetto sportivo AMG
	Assale anteriore Sx	for vehicles without sports brake system	per veicoli senza impianti frenante sportivo
	Assale anteriore Dx	France	Francia
+ eFSB	per veicoli con freno stazionamento elettrico	Great Britain	Gran Bretagna
+ ESP	per veicoli con ESP	Height [mm]	Altezza [mm]
+PR	per N° PR	Height 1 [mm]	Altezza 1 [mm]
+ WE	Predisposto per contatto segnalazione usura	Height 2 [mm]	Altezza 2 [mm]
+ WK	con segnalatore acustico usura	Internal Thread 1 [mm]	Filettatura interna 1 [mm]
+ Zub	con accessori	L=	Lunghezza [mm]
19"	19"	L1=	Lunghezza 1 [mm]
Abfrage Produktbild vorhanden	Abfrage Produktbild vorhanden	L2=	Lunghezza 2 [mm]
AKE	Sistema frenante, Akebono	MAN	Sistema frenante, Mando
ATE Ceramic	Denominazione aggiuntiva dell'articolo, ATE Ceramic	Manufacturer Restriction	Limitazione costruttore
Brake Size	Misura freno	Piston Diameter [mm]	Diametro pistone [mm]
BRE	Sistema frenante, Brembo	Produkttyp vorhanden	Produkttyp vorhanden
Country specific package and status data	Informazioni di imballaggio e di stato specifiche per i diversi Paesi	Reached Quality Gates	Reached Quality Gates
Disc Brake	Freno a disco	replacement part	Ricambio di rotazione
Drum Brake	Freno a tamburo	Rim Size [in]	Misura cerchione [pollici]
- eFSB	per veicoli senza freno stazionamento elettrico	Service exchange part	Ricambio di rotazione
Engine Code	Codice motore		
for brake disc diameter [mm]	per diametro disco freno [mm]		



Technical translations

Technische Übersetzungen - Traducciones tecnicas - Traductions techniques - Traduzioni tecniche

IT	
Slovakia	Repubblica slovacca
Spanner Size	Apertura chiave
Spanner size 1 [mm]	Apertura chiave 1 [mm]
Spanner size 2 [mm]	Apertura chiave 2 [mm]
Thickness [mm]	Spessore [mm]
Thickness 1 [mm]	Spessore 1 [mm]
Thickness 2 [mm]	Spessore 2 [mm]
TOK	Sistema frenante, Tokico
TRW	Sistema frenante, Lucas / TRW
usage number	Codice d'uso
Vehicle Main Current	Tipo imp. elettrico di bordo
Vehicle Production Country	Paese produzione veicolo
- WE	Non predisposto per contatto segnalazione usura
Width [mm]	Larghezza [mm]
with anti-squeak plate	con lamierino anticigolio
with brake caliper screws	con bulloni pinza freno
without brake fluid reservoir	senza serbatoio liquido freni
- WK	senza contatto segnalazione usura
x	N° raccordi
Yes	Sì
Ø	Diametro [mm]
→	Anno da N° telaio (VIN) da
→	Anno fino a N° telaio (VIN) fino a

ATE – A Trademark of the
Continental Corporation

**Continental Aftermarket &
Services GmbH**

Sodener Straße 9
D-65824 Schwalbach
Tel. +49 (0) 6196 87 0
Fax +49 (0) 6196 865 71

www.ate.de

**Continental Automotive Trading
Italia S.r.l.**

Via Matteotti, 62
I-20092 Cinisello Balsamo (MI)
Tel. +39 02 35680 1
Fax +39 02 35680 325
E-Mail: supporto@continental-corporation.com

www.ate-freni.it

**Continental Automotive Trading
France**

6 rue Jean Moulin
F-78120 Rambouillet
Tél. +33 (0)9 69 37 37 37

www.ate-freinage.fr

Continental Automotive Spain, S.A.

C/ Sepúlveda, 11
E-28108 Alcobendas (Madrid) Phone
+34 (0) 657 21 21
Fax +34 (0)91 657 21 49

www.frenos-ate.es